



**LBIW Inc.**

2020 WEST 14TH STREET  
 LONG BEACH, CA. 90813  
 Tel No. : (562) 432.5451  
 Fax No. : (562) 432.5929  
 www.lbiw.com

**PRODUCT NUMBER**  
**36RX GRATE**  
**BICYCLE**  
**PROOF GRATE**

**COATING**  
 MILL FINISH OR  
 GALVANIZED

**EST. WEIGHT**

WEIGHTS MAY VARY  
 MINUS 5%, PLUS 10%

**SPECIFICATION**  
 D75A, D77B

**OPEN AREA**

**DESIGNATES MACHINED**

<b>DRAWN</b> EB	<b>DATE</b> 03-09-09
--------------------	-------------------------

**REFERENCE INFORMATION**

SECTION 08

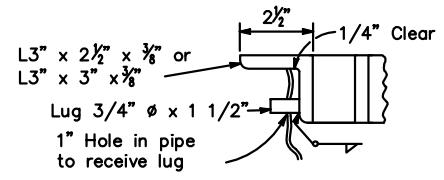
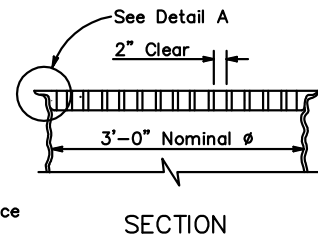
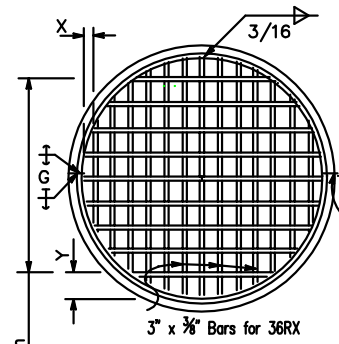

DETAIL A

Provide cross bars on Type 36RX - optional spacing 4 or 6

PLAN

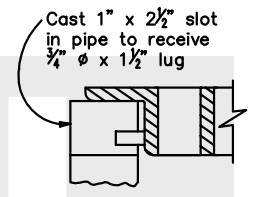
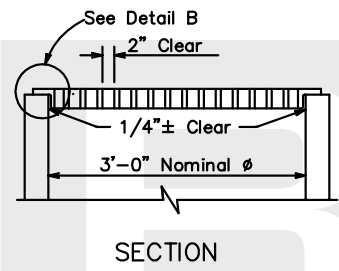

DETAIL B

SECTION

GRATE DETAILS

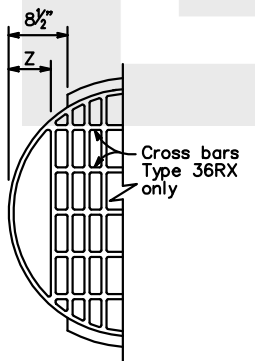

CROSS BAR DETAIL (WELDED STEEL)

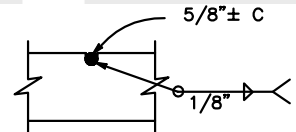

5/8" ± c  
 1/8"  
 3/8" ± φ Cross bars may be fillet welded, resistance welded or electroforged to bearing bars.

GRATE BAR SPACING TABLE

TYPE	No. OF BARS	CLEAR BAR SPACING	X	Y		Z
				4" SPACING	6" SPACING	
36RX (Steel)	15	2"	3/16"	3 3/4"	5 3/4"	-

36RX GRATE DETAILS